

# Temperature Measuring Metal Detector Security Gate

---

Quick Start Guide

Please read the Quick Start Guide carefully before using the product and keep it.

Related tools and documents of products, please download from

*<http://www.herospeed.net>.*

## Statement

- Thank you for using our products, please read this manual carefully before trying.
- This manual is applicable to temperature measuring metal detector security gate series products.
- This manual may contain information that is technically inaccurate, inconsistent in the product's function and operation, or in a typographical error. Our company will update the context in the manual according to the enhancement of product features. Updated content will be added in the new version of this manual without further notice.
- If there is manual description of the product does not match with the physical, in order to prevail in kind.

## Safety Precautions

- This product is only suitable for indoor use. If it needs to be installed outdoors, it should be equipped with rainproof facilities such as canopy. When using indoors, ensure that the indoor ambient temperature is between 10° C and 35° C. If it exceeds this temperature range, the accuracy of the device's temperature measurement cannot be guaranteed.
- There should be no large metal and strong magnetic field within 2 meters around the detection door to avoid interference. If there is a metal door near the installation site, the distance between the metal detection door and the door must be more than 1000mm (depending on the size of the door).
- The installation site should be as far away as possible from power lines and communication cables.
- Do not install in high temperature, humidity, direct sunlight, or poorly ventilated spaces, such as near heaters or heating sources (ignoring this item may cause fire hazard).
- Do not install the device in extremely cold places, such as the air outlet of an air conditioner.
- Do not aim the camera lens at a strong light source, such as the sun, fluorescent lamps and other high-temperature heat sources, otherwise the lens or thermal detector will be damaged.
- Do not aim the camera lens at a cold source, such as air conditioning vents, cold drinks, ice cubes, etc.
- Non-professionals are not allowed to disassemble and adjust the components on the electrical control box without authorization.

- After the security gate is turned on, it needs to self-check for 1-2 minutes before working to achieve the best detection effect.
- Please install the security gate steadily on a flat, vibration-free ground. When people pass the security gate, they should avoid collision with the gate.
- Before installation, the left and right door panels must be distinguished correctly, and the signal probe line and zone display line must be inserted into the corresponding marked positions.
- In order to get high quality video and pictures, make sure your internet connection is stable and smooth.
- When the device is connected to the Internet, it may face network security issues. Please strengthen the protection of personal information and data security.
- Please understand that you are responsible for properly configuring all passwords and other related product security settings, and keeping your user name and password properly.

## Disclaimer

The following exemptions or limitations of liability, please pay special attention to:

1. As a result of the following reasons, if the product interrupts or terminates the service for any of the following reasons, the company shall not be liable for personal injury or property damage to you or a third party. Failure to install or use properly as required; for the sake of national or public interest; force majeure; your own or third-party reasons (including but not limited to the use of third-party products, software or components, etc.
2. The company has not expressed or implied that this product is applicable to special purpose. This product may not be used in medical / safety equipment or other applications where there is a breakdown of the product that could result in life-threatening or personal injury, as well as hazardous or non-humanitarian hazards such as weapons of mass destruction, biological and chemical weapons, nuclear explosions or any unsafe use of nuclear energy use. Any loss or liability arising out of the above use will be at your own risk.
3. This product, when properly installed and used, can detect unauthorized intrusion during a particular delight but can not avoid accidents or personal injury or property damage. In your daily life, you should be vigilant and strengthen your safety awareness.
4. The Company is not responsible for any indirect, incidental, special punitive damages, claims, loss of property or loss of any data or documents. To the maximum extent permitted by law, the liability for compensation of company is not exceed than the amount you paid for this product.

## Contents

1. Product Introduction.....	1
1.1. Product description.....	1
1.2. Introduction of product appearance.....	1
2. Product Installation.....	2
2.1. Packing List.....	2
2.2. TF card Installation.....	3
2.3. Install Security Gate.....	5
3. Instructions.....	10
3.1. Camera configuration.....	10
3.1.1. Network Setting.....	10
3.1.2. Modify password.....	11
3.1.3. Real-time preview.....	12
3.1.4. Parameter Configuration.....	12
3.1.5. Temperature Measure Configuration.....	13
3.1.6. NVR adds IPC.....	13
3.1.7. iVMS320 Client Access.....	14
3.1.8. Mobile App Access.....	14
3.2. Metal detector configuration.....	15
3.2.1. Sensitivity Configuration.....	15
3.2.2. Sound Configuration.....	15
3.2.3. Reset to Factory Setting.....	15

## 1. Product Introduction

### 1.1. Product description

Temperature Measuring Metal Detector Security Gate is a fusion of infrared temperature measurement and metal detection. When people pass the security gate, the equipment will perform temperature detection and metal detection on them. When a suspected fever person whose body temperature exceeds 37.3°C is detected, the system will automatically give an audible and visual alarm. When a metal alarm occurs, you can accurately determine the location of the metal object through the 6 alarm locations of the LED lights on the right doorpost, record the passing data, and separately record the number of passing people and the number of alarms.

Temperature Measuring Metal Detector Security Gate can manage multiple devices through a PC and dedicated software, and realize multiple functions such as infrared non-contact temperature measurement, face recognition, face capture, sound and light alarm, real-time monitoring, remote viewing, and remote settings. The measurable temperature is 35°C-42°C, which is widely used in airports, schools, office buildings, museums, shopping malls, banks, stations and other places where new personnel passages can be built.

### 1.2. Introduction of product appearance

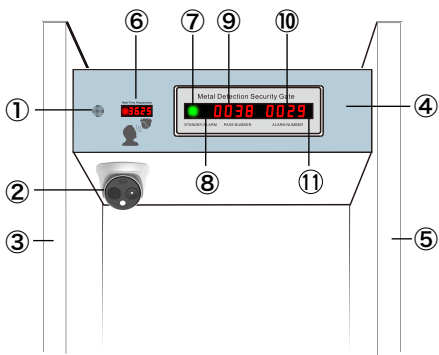

- ① Speaker
- ② Bi-spectrum Image Fusion Smart IP camera
- ③ The left door panel. When the passing target temperature exceeds the threshold, the light on the door panel lights up and alarms.
- ④ Lead plane
- ⑤ The right door panel. When a passing person carries a metal object, the light of the area corresponding to the metal on the door panel will light up and alarm.
- ⑥ Temperature alarm light + temperature display
- ⑦ Standby light
- ⑧ Metal warning light
- ⑨ Count of people passed
- ⑩ Count of metal alarm
- ⑪ Metal strength warning light

## 2.Product Installation

### 2.1. Packing list

- Before installation, please confirm that the equipment in the packing box is in good condition, and confirm the products and accessories according to the following list.

Carton	Accessories	Quantity
Carton 1-Lead plane	Lead plane	1
	Remote control	1
	Screws	1
	Power cable	1
	Quick Operation Manual	1
Carton 2-Door Panel	Door Panel -Left	1
	Door Panel - Right	1
Carton 3-Camera	Camera	1
	Screws	1

- When transporting the camera, do not directly pull the cable at the rear of the camera, otherwise it may affect the waterproof performance of the camera or cause circuit problems.

## 2.2. TF card installation

If you need to use an TF card to store video, pictures and other data, please install the TF card before installing the device. If you don't need to use TF card to store data, please skip this chapter.



Warning

After installing the TF card in the IPC, you need to install it according to the method before disassembly, otherwise it will affect the airtightness of the camera and thus affect the normal use of the device.

Step 1 Use an internal torx wrench to loosen the set screw, and separate the base, high tube and ball core.

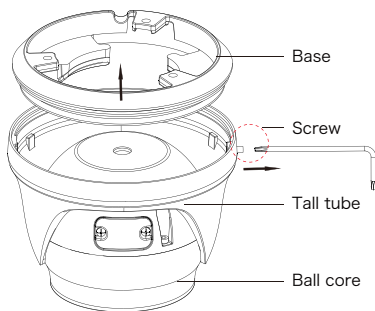

### 2.3. Install security gate

Step 1 Place equipment and accessories horizontally. The display panel of the main unit should be facing upwards (foam should be placed under the main unit, and be careful not to press the power switch at the backwards). Align [Left Door Panel] with [Left Main Box Interface] according to the logo guidelines. The operation on the other side is the same.

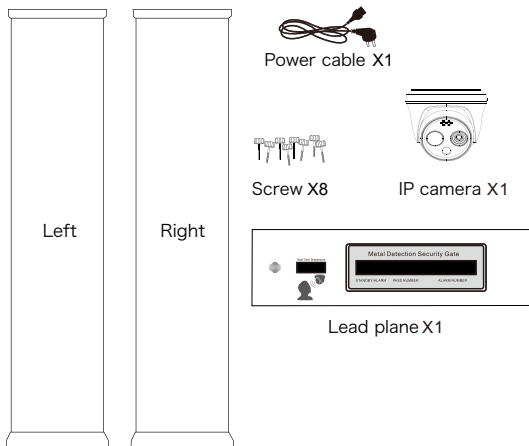

Step 2 Tear off the sticker on the bottom of the main body of the security door ("Threading Hole" mark), align the screw holes of the base with the screw holes on the bottom of the main body, and lock the screws.

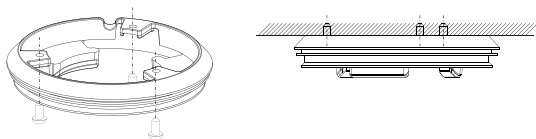



Step 2 Use a Phillips screwdriver to unscrew the TF card slot cover.

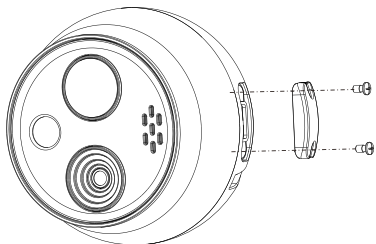

Step 3 Insert the TF card into the card slot slowly, and when you hear a "click" sound, the installation is complete.

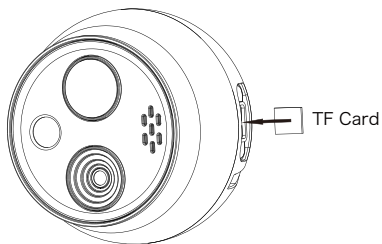

Step 4 Close the TF card cover and tighten the screws.

Step 3 Pass the cable through the base, put the hemisphere into the high tube, and slowly move the body upwards, so that the high tube clamping position is engaged with the base slot and finally sleeved into the base.

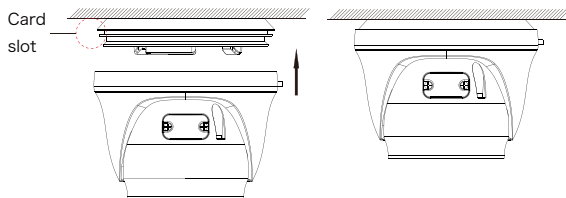

Step 4 Adjust the lens angle as needed, and tighten the set screw on the right side of the device.

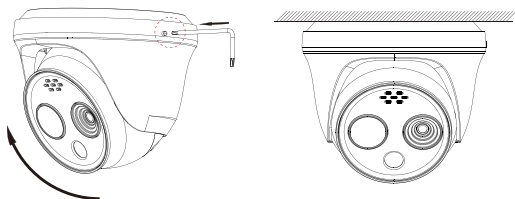

Step 5 Arrange and connect the camera's power cable, network cable, 485 cable (red to alarm port 5, black to alarm port 6) and other cables, and insulate the power cord.

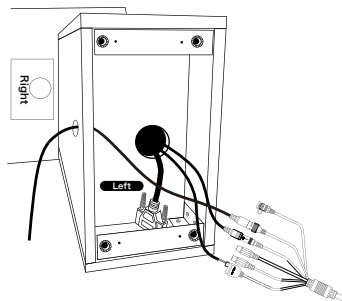

Note: You can connect network cables, audio input, output, and alarm wiring as needed. Network cables and other external wiring materials can be routed from the top of the main body. The specific wire interface is as follows:

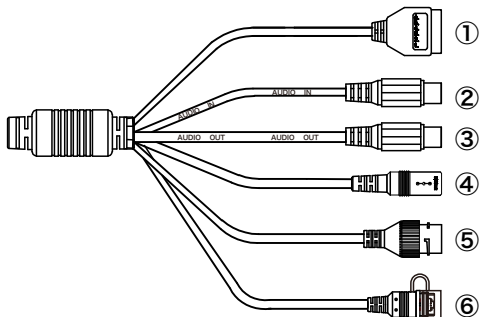

- ① Alarm interface: including alarm input and alarm output, a group of inputs, a group of outputs and RS485 (used to connect external devices with RS-485 interface).

Alarm Input		Alarm Output		RS485	
1	2	3	4	5	6
+	-	A	B	485+	485-

- ② Audio input interface: 1 channel audio input, used to connect audio pickup to collect sound.
- ③ Audio output interface: 1 audio output, used to connect speakers and other equipment to output audio (Does not support external audio devices temporarily) .
- ④ Power interface: support DC12V, POE power supply. If it is DC12V, please connect the positive and negative power supply correctly.
- ⑤ Network port interface: used to access Ethernet through RJ45 and power the device through POE.
- ⑥ Reset interface: Long press the reset button for 10 seconds, the device will be restored to the factory default parameters.

Step 6 Connect the wire marked "Left" to the interface and tighten the screws. Align the "Left" door panel with the holes of the main body and tighten the screws (the operation on the other side is the same).

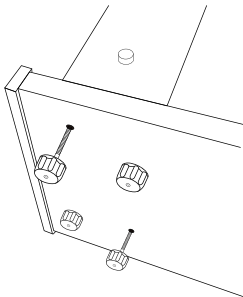

Step 7 Take out the power cord and insert it into the power socket of the lead plane, and turn on the switch.

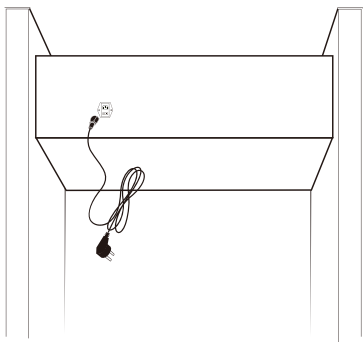

Step 8 Lift the security gate to a vertical position, turn on the power, and the installation is complete.

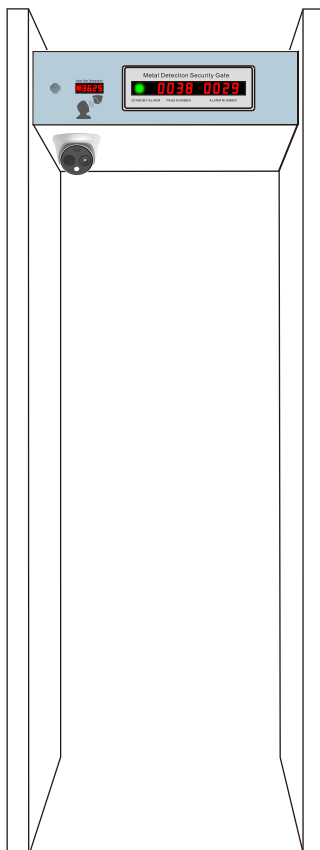

## 3. Instructions

### 3.1. Camera configuration

#### 3.1.1. Network setting

When configuring network parameters, ensure that the IPC address and the computer's IPv4 address are on the same network segment.

The network configuration Step s are as follows:

Step 1 Open [  Search Tool] (Version 7.2.45.6 and above, please install Search Tool from <http://www.herospeed.net>).

Step 2 Check 192.168.1.168.

Step 3 Modify the relevant network parameters such as IP on the right side of the interface

Step 4 Enter the user name (default is admin) and password (default is admin) of the device.

Step 5 Click [Modify] → [Confirm].

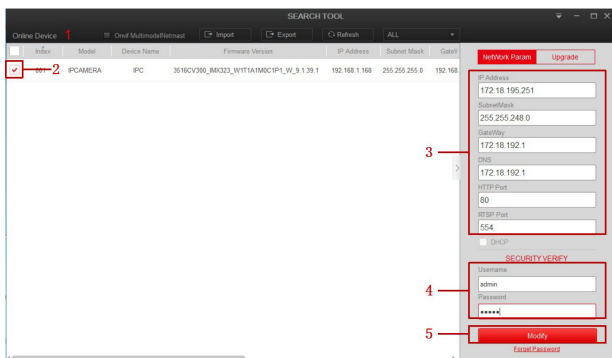

Step 6 Click [Refresh] to find the IP address that has been modified, which means that the network configuration is successful.

### 3.1.2. Modify password

Step 1 Open the IE browser, enter the IP address of IP Camera, and press [Enter].

Step 2 Click [Download] to download the plug-in, close the browser, and follow the prompts to install the plug-in.

Step 3 Enter the user name (admin) and password (admin) of the device, and click [Login].

Step 4 Click[Modify], enter the password, confirm the password, and set the security question, click [Key Export] → [Save].

#### User Management

---

Users to edit	
User Name	<input type="text" value="admin"/>
User Type	<input type="text" value="Admin"/> ▼
Old password	<input type="text"/>
<input checked="" type="checkbox"/> Modify Password	
Password	<input type="text"/>
Confirm Password	<input type="text"/>
<input checked="" type="checkbox"/> Do you want to set a new security question	
Security issue1	<input type="text"/> ▼
Answer1	<input type="text"/>
Security issue2	<input type="text"/> ▼
Answer2	<input type="text"/>
Security issue3	<input type="text"/> ▼
Answer3	<input type="text"/>

If you forget the security problem and don't have the key file, you need to return the equipment to the factory.

## 3.1.3. Real-time preview

After login, enter the real-time preview interface of the device.

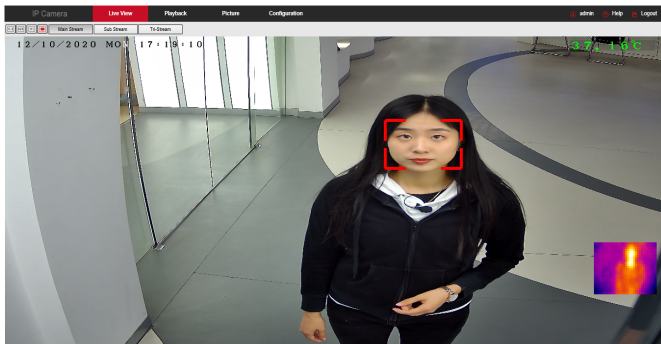

## 3.1.4. Parameter configuration

Click [Configuration] to enter the parameter configuration interface of the device, which includes local configuration, system, local network, video, image, event and other functional configurations. Users can selectively set these functions according to actual application scenarios to achieve the best monitoring effect.

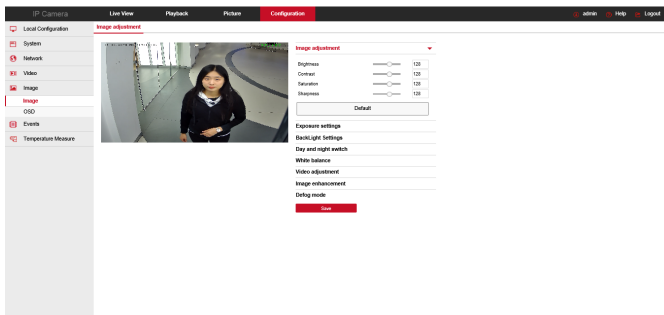



### 3.1.5. Temperature measure configuration

Step 1 On the main interface, click [Configuration] → [Temperature Measure] → [Temperature Measure] to enter the body temperature measurement configuration interface.

Temperature measurement config
Linkage Method

- Temperature measurement function switch
- Temperature information display switch
- Heat map display switch

Temperature compensation	0	℃ (Compensation range -5~5)
Temperature measurement alarm threshold	37.3	℃ (Temperature measurement alarm threshold range is 36~42)
Temperature measurement position display	Upper right corner	
Heat map display position	Lower right corner	
Temperature measurement trigger	Detect face	
Temperature measurement interval	3 S	
Temperature measurement unit	Celsius temperature(℃)	
Temperature measurement range	35-42	
Temperature measurement distance	1.5	Meter

Save

Step 2 Configure related temperature measurement parameters and click [Save].

Step 3 Click [Linkage Method]→[Arming Schedule] to set the arming time.

Step 4 Click [Linkage Method] to set the linkage method.

Step 5 Click [Save] to complete the human body temperature measurement configuration.

### 3.1.6. NVR adds IPC

Before adding devices, please make sure that the IP addresses of NVR and IPC are on the same network segment and do not conflict. Click [Channel] → [Camera] → [Search] under the NVR main menu, check the devices to be added, and click [Add].

Note: In the main menu of NVR, you can also perform operations such as video settings, video playback, motion detection, and encoding parameter settings.

### 3.1.7. iVMS320 client access

Step 1 Open your browser and visit <http://www.herospeed.net/>.

Step 2 Click [PC Client] → [iVMS320 (Windows)] or [iVMS320 (Mac)] to download the latest version of the video management system [iVMS320].

Step 3 Follow the prompts to install and add devices to view and manage the devices.

### 3.1.8. Mobile app access

Scan the QR code below to download and install the BitVision App.



After registering and logging in, you can add the device, and remotely view and manage the device on the mobile phone.

## 3.2. Metal detector configuration

### 3.2.1. Sensitivity configuration

The right door panel can display 6 alarm areas through LED lights. The sensitivity of each zone can be adjusted by the remote control: the highest sensitivity can detect metal the size of a RMB coin. The sensitivity of each zone can be adjusted between 0-99.

The sensitivity configuration Steps are as follows:

Step 1: Press [SELECT] button, 1234 will appear in the position of the alarm times on the panel. Press [ENTER] button and C000 will appear.

Step 2: Press [ENTER] button, 1—99 appears, indicating that the sensitivity of the first zone is 99.

Step 3: Press the [ADJUST] button to adjust the sensitivity. The larger the number, the higher the sensitivity.

Step 4: Press the [SELECT] button, [2-99] appears, indicating that the sensitivity of the second zone is 99, press the [ADJUST] button to adjust to the appropriate value.

Step 5: Press the [SELECT] button to enter the next zone setting. Press [ADJUST] to adjust the sensitivity value. After setting the six areas by analogy, press the [ENTER] button to save.

### 3.2.2. Sound configuration

Press [voice] on the remote control to turn off/on the sound of the security door.

### 3.2.3. Reset to factory setting

Long press the [RESET] button on the remote control for 10 seconds to clear the number of people passing and the number of alarms, and restore the previous settings to the factory settings.

